

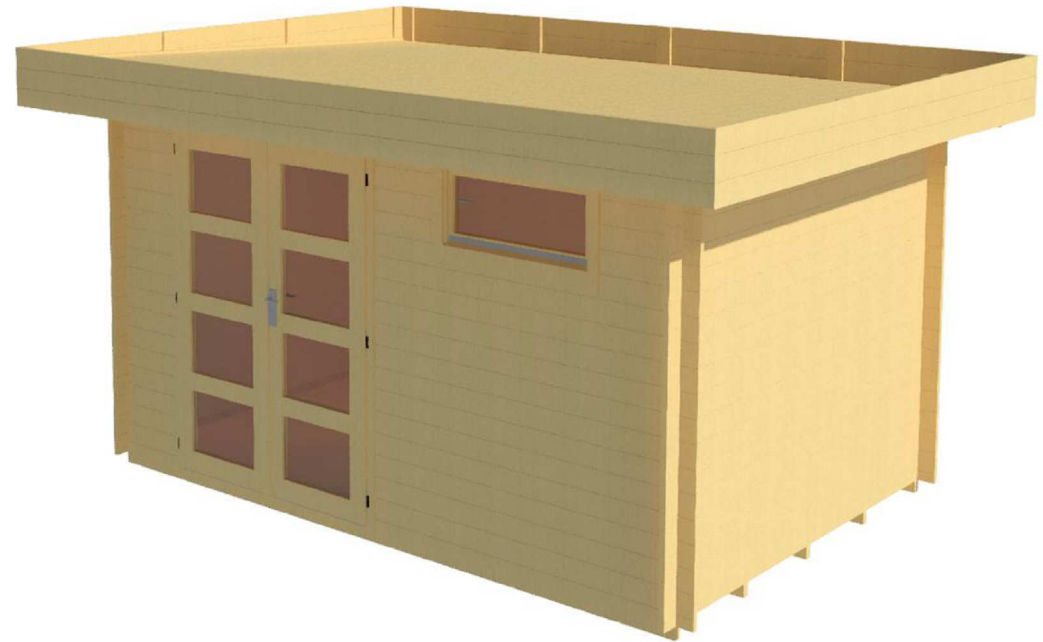

# Christina 28 (370x250)

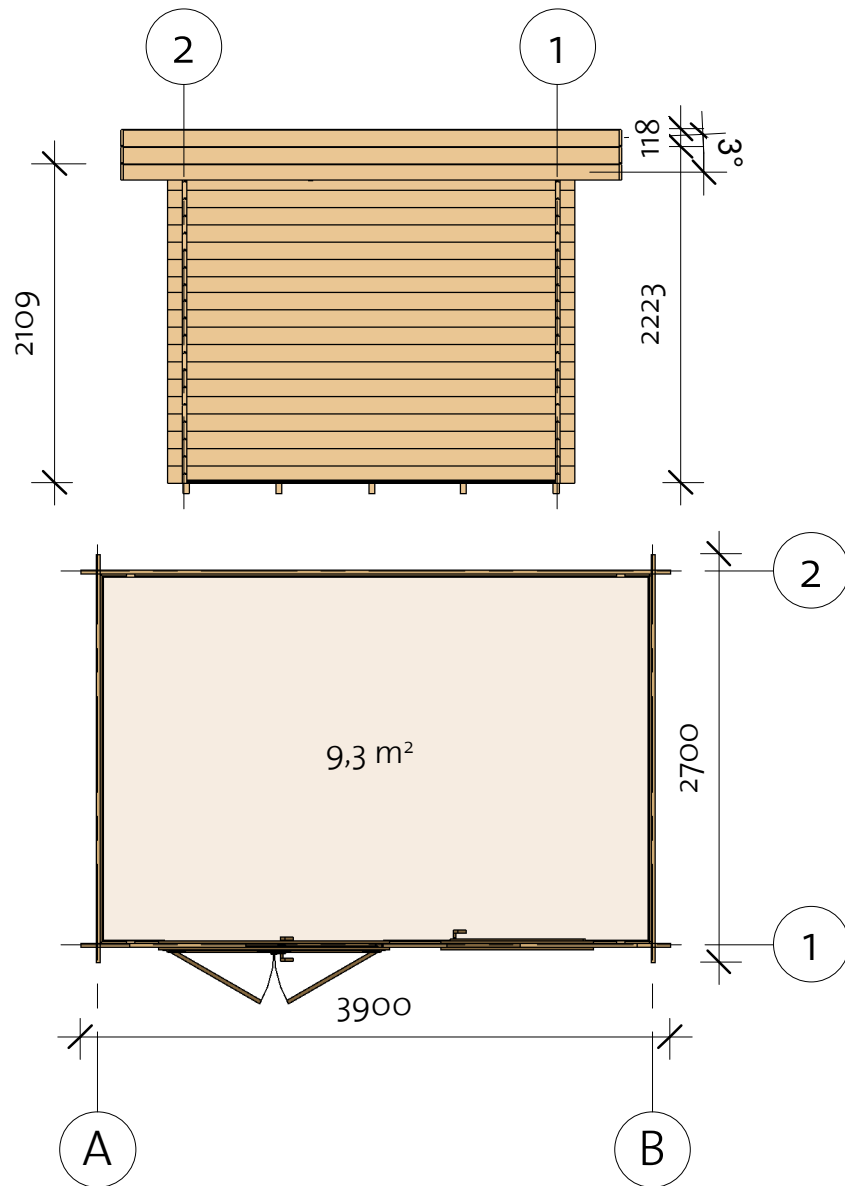

# Christina 28 (370x250)

Foundation

| Impregnated foundation beams |      |         |       |        |
|------------------------------|------|---------|-------|--------|
| Mark                         | Type | Profile | Count | Length |

|     |              |   |   |      |
|-----|--------------|---|---|------|
| IFB | IFB<br>40x70 |  | 5 | 3690 |
|-----|--------------|---|---|------|

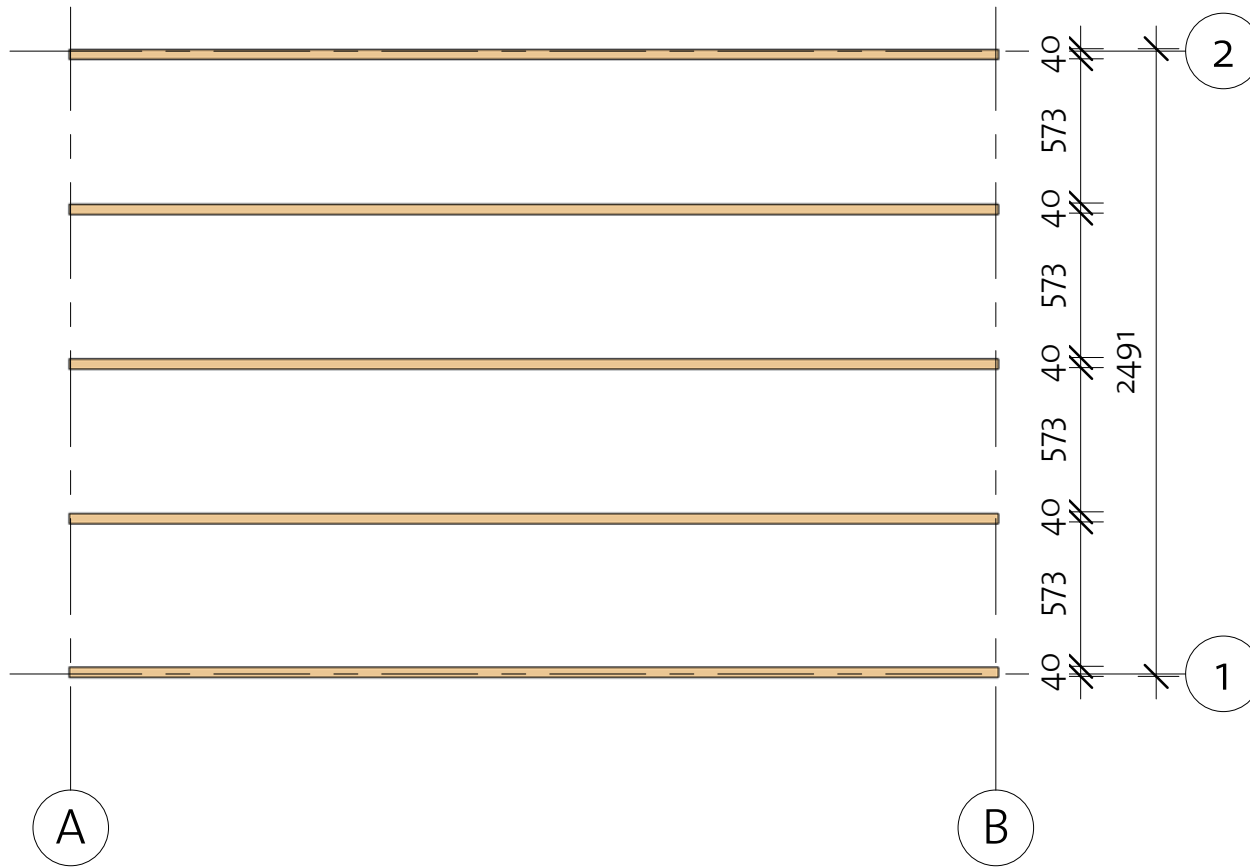



# Christina 28 (370x250)

Floor Plan

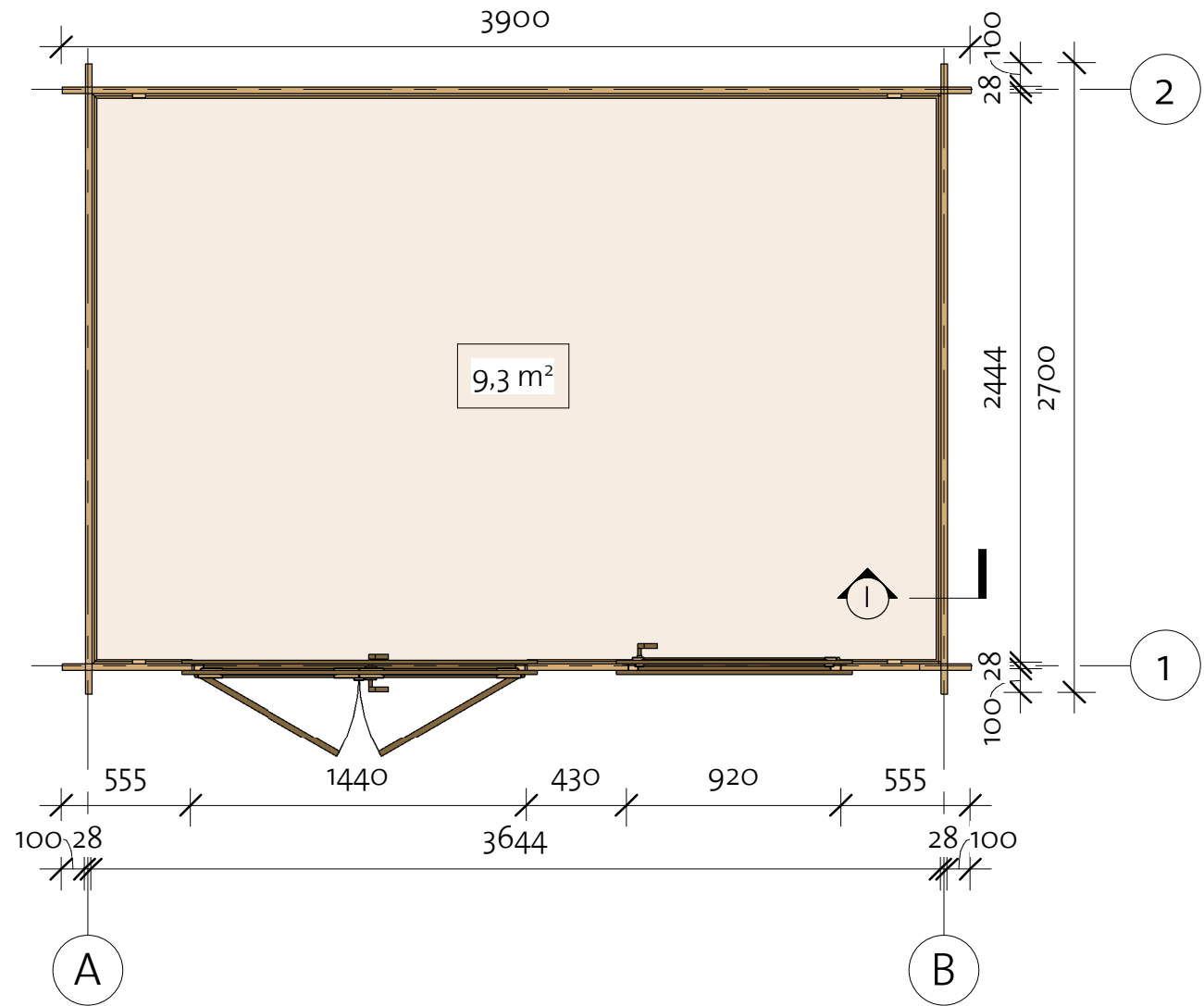
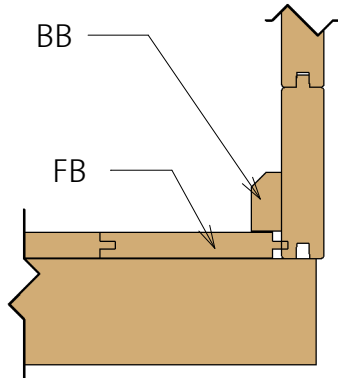
① Baseboard



Floor Schedule

| Mark | Type      | Profile   | Count | Length |
|------|-----------|---|-------|--------|
| FB   | FB 17x114 |  | 33    | 2440   |
| BB1  | BB 20x40  |  | 2     | 2500   |
| BB2  | BB 20x40  |   | 2     | 3700   |

4000010\_210521





# Christina 28 (370x250)

Wall A

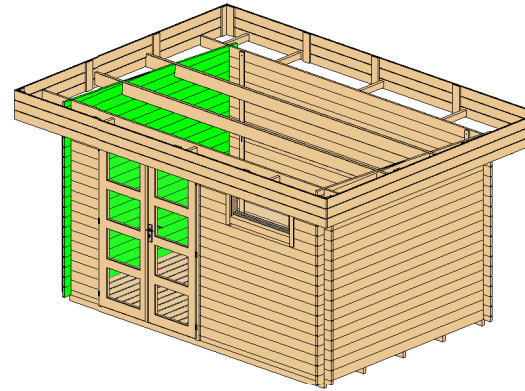

| Wall A |         |       |            |
|--------|---------|-------|------------|
| Mark   | Profile | Count | Cut Length |

|         |        |    |      |
|---------|--------|----|------|
| ALG 1 * | 28x114 | 1  | 1365 |
| ALG 2 * | 28x114 | 1  | 2700 |
| ALG 3   | 28x114 | 17 | 2700 |
| ALG 4 * | 28x114 | 1  | 2700 |

\* Gable - delivered premounted

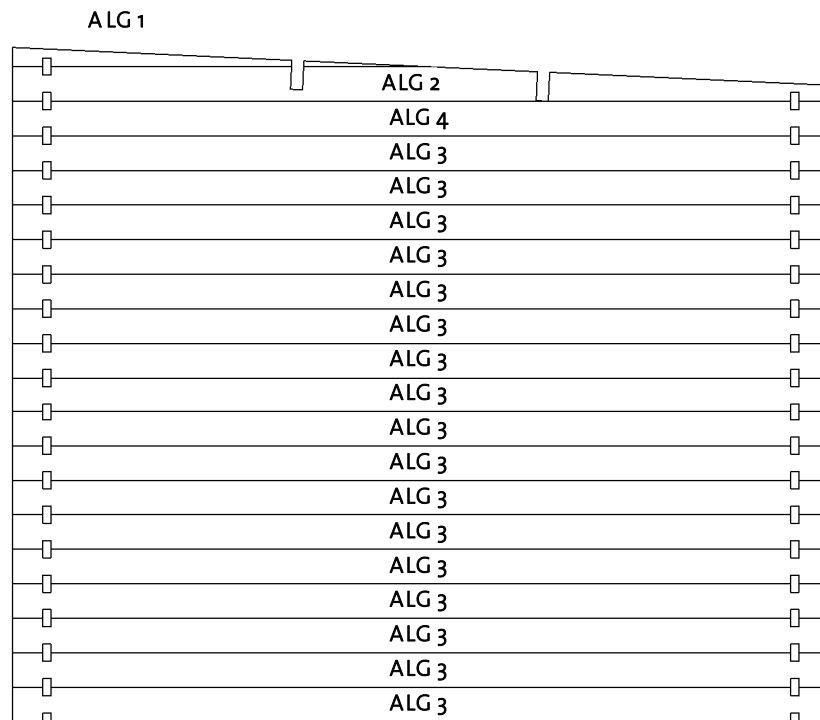

2700

4000010\_210521

| Log Profile Wall A |         |
|--------------------|---------|
| Profile            | Profile |

|        |  |
|--------|--|
| 28x114 |  |
|--------|--|

# Christina 28 (370x250)

Wall B

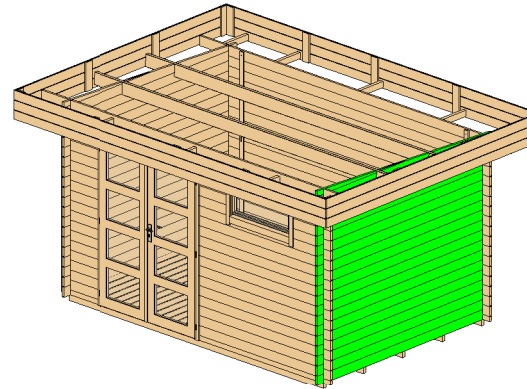

| Wall B |         |       |            |
|--------|---------|-------|------------|
| Mark   | Profile | Count | Cut Length |

|         |        |    |      |
|---------|--------|----|------|
| BLG 1 * | 28x114 | 1  | 1365 |
| BLG 2 * | 28x114 | 1  | 2700 |
| BLG 3   | 28x114 | 17 | 2700 |
| BLG 4 * | 28x114 | 1  | 2700 |

\* Gable - delivered premounted

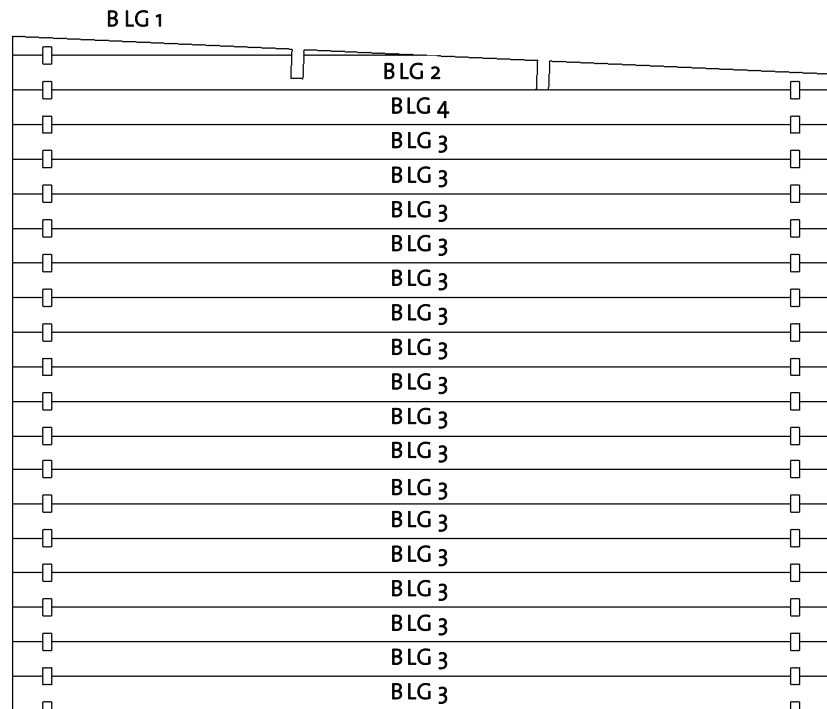

2700

| Log Profile Wall B |         |
|--------------------|---------|
| Profile            | Profile |

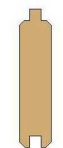

28x114



# Christina 28 (370x250)

Roof 1

| Roof |      |         |       |        |
|------|------|---------|-------|--------|
| Mark | Type | Profile | Count | Length |

|     |                |   |    |      |
|-----|----------------|---|----|------|
| RB  | 17x114         |  | 40 | 3230 |
| RE1 | 40x70          |  | 8  | 390  |
| RFB | Beam<br>40x143 |  | 2  | 4480 |

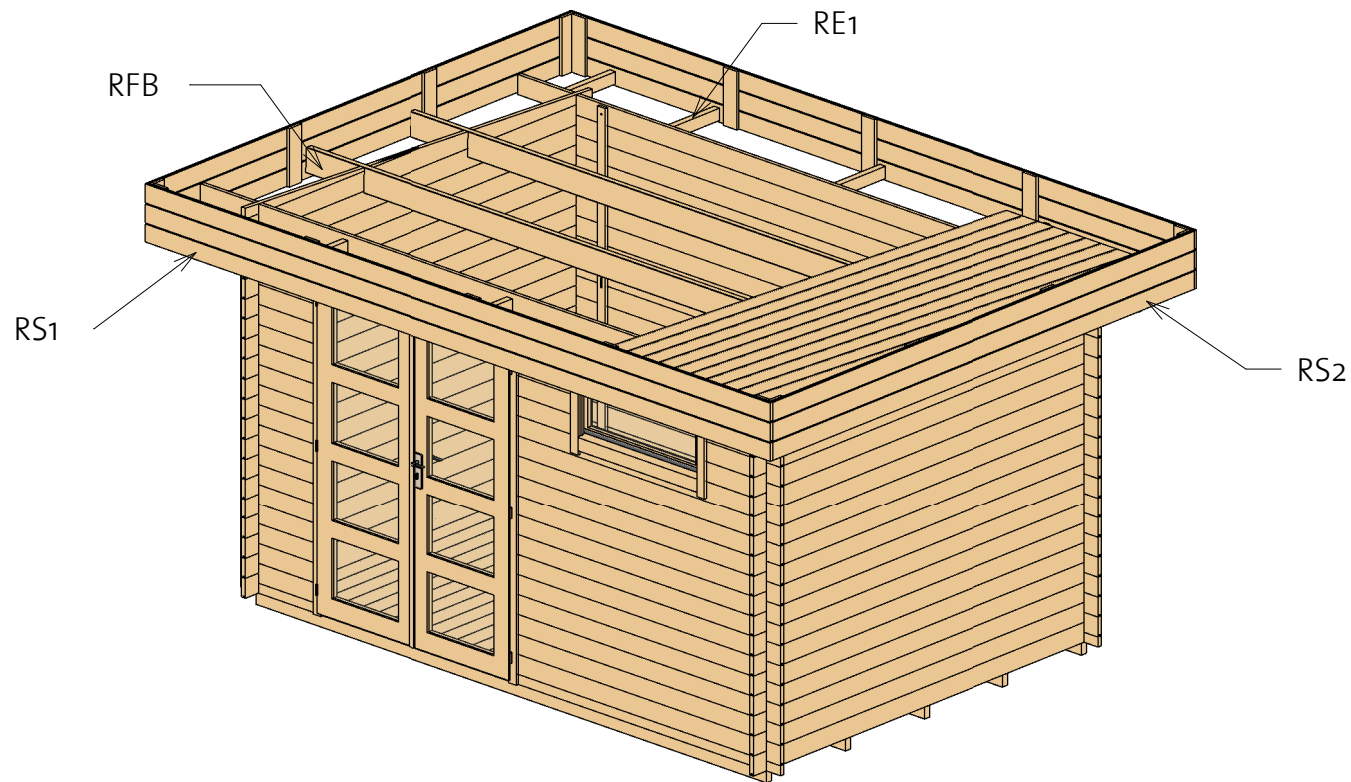

| Roof Side Schedule |        |       |
|--------------------|--------|-------|
| Type               | Length | Count |

|     |      |   |
|-----|------|---|
| RS1 | 4516 | 2 |
| RS2 | 3280 | 2 |



# Christina 28 (370x250)

Roof 2

| Fascia Schedule |      |         |       |        |
|-----------------|------|---------|-------|--------|
| Mark            | Type | Profile | Count | Length |

|     |                   |   |   |      |
|-----|-------------------|---|---|------|
| EE1 | Eave Edging 18x40 |  | 1 | 4444 |
| EE2 | Eave Edging 18x40 |  | 2 | 3172 |

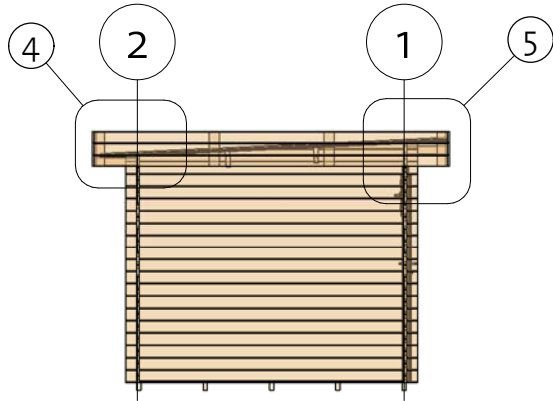

④ Roof - Callout Back

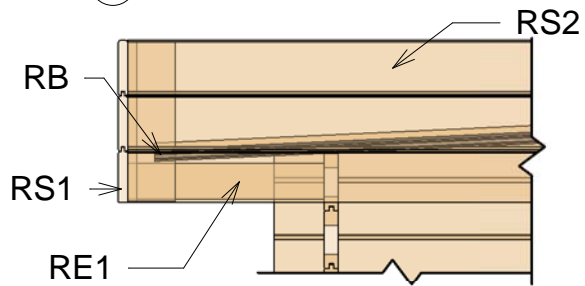

⑤ Roof - Callout Front

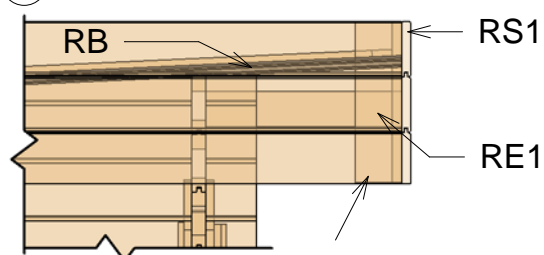

4000010\_190823

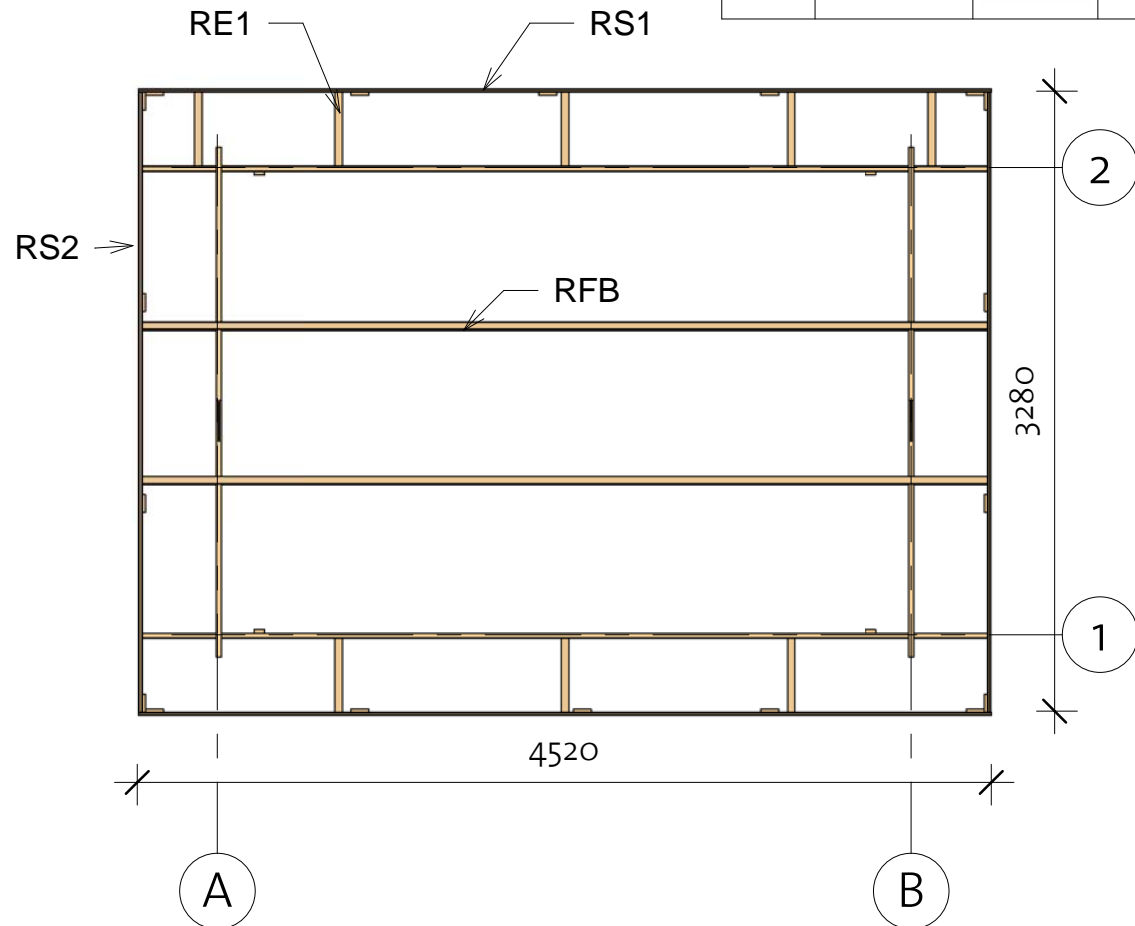

# Christina 28 (370x250)

Extras

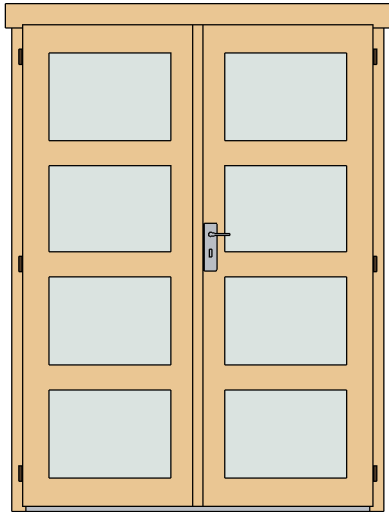

| Door Schedule |                                       |       |        |       |
|---------------|---------------------------------------|-------|--------|-------|
| Model         | Type                                  | Width | Height | Count |
| BDD4R         | Basic double door 4, four glass right | 1425  | 1955   | 1     |

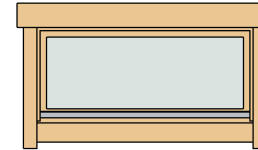

| Window Schedule |                                 |       |        |       |
|-----------------|---------------------------------|-------|--------|-------|
| Model           | Type                            | Width | Height | Count |
| BW2L            | Basic window 2, full glass left | 915   | 420    | 1     |

| Fasteners & Extras |          |       |
|--------------------|----------|-------|
| Name               | Comments | Count |

|          |            |     |
|----------|------------|-----|
| Hitblock | 300-400 mm |     |
| Bolts    | M8 x 60    | 12  |
| Screws   | 5,0 x 70   | 25  |
| Nails    | 1,4 x 40   | 30  |
| Screws   | 6,0 x 140  | 80  |
| Screws   | 4,0 x 50   | 400 |



| Type            | Count | Length |
|-----------------|-------|--------|
| Windboard 18x40 | 4     | 2200   |

4000010\_210521

# Christina 28 (370x250)

## List of all items 1



### Impregnated foundation beams

| Mark | Type | Profile | Count | Length |
|------|------|---------|-------|--------|
|------|------|---------|-------|--------|

|     |              |   |   |      |
|-----|--------------|---|---|------|
| IFB | IFB<br>40x70 |  | 5 | 3690 |
|-----|--------------|---|---|------|

### Roof

| Mark | Type | Profile | Count | Length |
|------|------|---------|-------|--------|
|------|------|---------|-------|--------|

|     |                |   |    |      |
|-----|----------------|---|----|------|
| RB  | 17x114         |    | 40 | 3230 |
| RE1 | 40x70          |  | 8  | 390  |
| RFB | Beam<br>40x143 |  | 2  | 4480 |

### Floor Schedule



| Mark | Type | Profile | Count | Length |
|------|------|---------|-------|--------|
|------|------|---------|-------|--------|

|    |           |   |    |      |
|----|-----------|---|----|------|
| FB | FB 17x114 |  | 33 | 2440 |
|----|-----------|---|----|------|

|     |             |   |   |      |
|-----|-------------|---|---|------|
| BB1 | BB<br>20x40 |  | 2 | 2500 |
| BB2 | BB<br>20x40 |   | 2 | 3700 |

### Fascia Schedule

| Mark | Type | Profile | Count | Length |
|------|------|---------|-------|--------|
|------|------|---------|-------|--------|

|     |                         |   |   |      |
|-----|-------------------------|---|---|------|
| EE1 | Eave<br>Edging<br>18x40 |  | 1 | 4444 |
| EE2 | Eave<br>Edging<br>18x40 |  | 2 | 3172 |

### Roof Side Schedule

| Type | Length | Count |
|------|--------|-------|
|------|--------|-------|

|     |      |   |
|-----|------|---|
| RS1 | 4516 | 2 |
| RS2 | 3280 | 2 |

# Christina 28 (370x250)

## List of all items 2

| Wall 1 |         |       |            |
|--------|---------|-------|------------|
| Mark   | Profile | Count | Cut Length |

|       |        |    |      |
|-------|--------|----|------|
| 1BL 1 | 28x57  | 1  | 555  |
| 1BL 2 | 28x57  | 1  | 1905 |
| 1LG 1 | 28x114 | 4  | 430  |
| 1LG 2 | 28x114 | 21 | 555  |
| 1LG 3 | 28x114 | 13 | 1905 |
| 1LG 4 | 28x114 | 1  | 3900 |
| 1TL 1 | 28x114 | 1  | 4480 |

| Wall A |         |       |            |
|--------|---------|-------|------------|
| Mark   | Profile | Count | Cut Length |

|         |        |    |      |
|---------|--------|----|------|
| ALG 1 * | 28x114 | 1  | 1365 |
| ALG 2 * | 28x114 | 1  | 2700 |
| ALG 3   | 28x114 | 17 | 2700 |
| ALG 4 * | 28x114 | 1  | 2700 |

| Wall 2 |         |       |            |
|--------|---------|-------|------------|
| Mark   | Profile | Count | Cut Length |



|       |        |    |      |
|-------|--------|----|------|
| 2BL 1 | 28x57  | 1  | 3900 |
| 2LG 1 | 28x114 | 17 | 3900 |
| 2TL 1 | 28x114 | 1  | 4480 |

| Wall B |         |       |            |
|--------|---------|-------|------------|
| Mark   | Profile | Count | Cut Length |

|         |        |    |      |
|---------|--------|----|------|
| BLG 1 * | 28x114 | 1  | 1365 |
| BLG 2 * | 28x114 | 1  | 2700 |
| BLG 3   | 28x114 | 17 | 2700 |
| BLG 4 * | 28x114 | 1  | 2700 |

\* Gable - delivered premounted

| Log Profiles |         |
|--------------|---------|
| Profile      | Profile |

|        |   |
|--------|---|
| 28x114 |  |
| 28x57  |  |
| 28x114 |  |